

NSAL SLOT DIFFUSER



Description:

An aluminium slot diffuser with movable vanes made of aluminium or plastic, divided into individually adjusted sections.

Intended use

NSAL-N slot diffusers are used in systems with constant or variable air volume. High air induction makes the NSAL diffusers capable of operating both in heating and cooling modes.

Design

NSAL diffusers can be made in lengths within the range of 500–2000 mm and they can contain between one to six movable, round air supply (extraction) slots. In the case of those white and grey (including the anodised version), the vanes are made of plastic. In the case of other colours, the vanes are made of aluminium. On special request, it is also possible to manufacture the aluminium vanes painted in white or grey. The diffuser can be painted in any RAL colour – please consult with your sales representative.

The diffusers can be installed individually or in a linear fashion. NSAL diffusers designed for inline mounting do not have a frame at the side where the diffusers are joined together, which makes it possible to maintain their attractive appearance.

Vane adjustment

The diffuser's design makes it possible to stream the air supply either vertically or horizontally by manually changing the angles of the individual vanes.

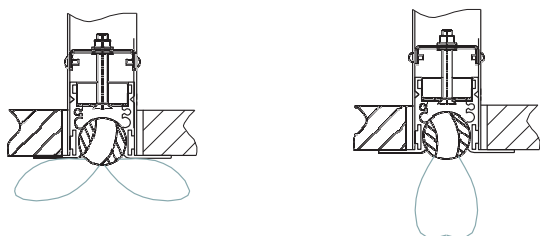

Figure 1. Horizontal air supply profile. Figure 2. Vertical air supply profile.

Table 1. Standard quantities and diameters of connection pipes \varnothing [mm]

Number of slots	Diffuser length L					
	500-700	800-900	1000-1100	1200-1400	1500-1700	1800-2000
1	1 x 98	1 x 98	2 x 98	2 x 98	2 x 123	2 x 123
2	1 x 123	1 x 123	2 x 123	2 x 158	2 x 158	2 x 198
3	1 x 158	2 x 158	2 x 158	2 x 198	2 x 198	2 x 198
4	1 x 198	2 x 158	2 x 198	2 x 198	2 x 198	2 x 198
5	1 x 198	2 x 158	2 x 198	2 x 198	2 x 198	2 x 198
6	1 x 198	2 x 158	2 x 198	2 x 198	2 x 198	2 x 198

Dimensions

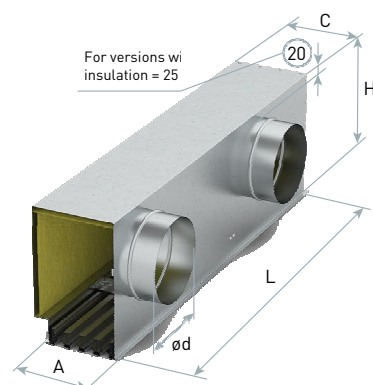

Figure 3. Dimensions of NSAL diffusers with a plenum box.

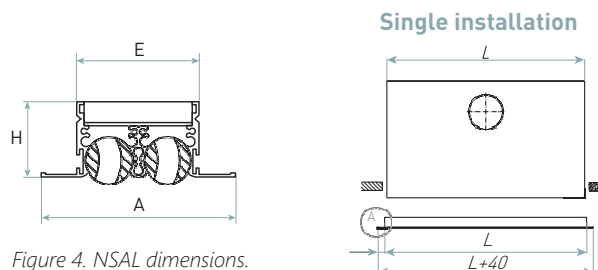
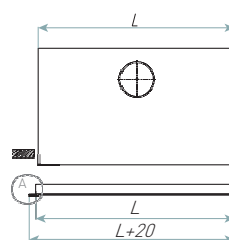

Figure 4. NSAL dimensions.

SK outermost element



WN middle element

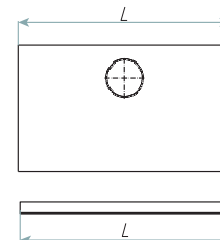

Figure 5. Dimensions of the plenum boxes for inline mounting.

Table 2. Standard dimensions of NSAL diffusers and plenum boxes.

Number of slots	Front panel			Non-insulated box		Insulated box	
	A [mm]	E [mm]	H [mm]	C [mm]	H ₁ [mm]	C [mm]	H ₁ [mm]
1	58	27	32	99	260	129	280
2	83	52	32	99	260	129	280
3	108	77	32	147	260	177	280
4	133	102	32	197	260	224	280
5	158	127	32	222	260	249	280
6	183	152	32	247	260	274	280

AA

AL

RAL



Installation

The diffusers may be mounted directly to the ceiling or by means of plenum boxes. Dedicated plenum boxes may be fitted with a control element on the inlet connection pipe. Plenum boxes may be optionally insulated from the inside with a 10 mm thick mat.



The technical data of the diffusers, including pressure drop, noise level and stream ranges, is available at smay.eu, in the "Flow Characteristic for Grilles and Diffusers" document.

Installation to a plenum box

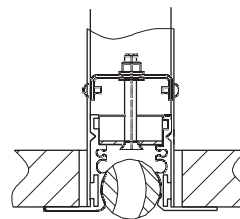

Installation to a baffle by means of a mounting bracket

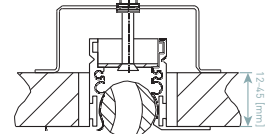

Installation to a baffle by means of visible screws

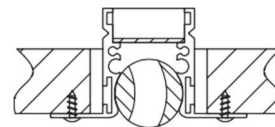

In the case of an individual order, the number and diameter of connection pipes may be adapted to the customer's requirements. In the case of a custom length, please consult with your sales representative.

NSAL – Slot diffuser

When ordering, please provide information in accordance with the following pattern:

NSAL - <W> - <L> - <X> - <M> - <P><RAL> / <ADD>

Where:

W	Number of the diffuser slots: 1, 2, 3, 4, 5, 6
L	Diffuser length in mm: 500-2000 (at intervals of 100 mm)
X	Type of diffuser installation*
	None – Single installation
	SK – Inline mounting, outermost element
	WN – Inline mounting, inner element
M	Installation method*
	None – To a plenum box
	Ks – By means of a mounting bracket
	Wk – By means of visible screws
P	Finish*
	AA – Frame made of anodised aluminium, vanes as per description
	AL – Frame made of painted aluminium, vanes as per description
RAL	colour number as per RAL (for AL finish)

Accessories:

Plenum box as per the configuration below:

SR <I> - <N> - <D><R>

Where:

I	Insulation*
	None – No insulation
	t – Insulated
N	Number of connection pipes*
D	Connection pipe diameter in mm*
R	Damper in a connection pipe*
	None – No damper
	P – Damper adjusted from outside the box
	Pc – Damper adjusted from inside the box with a cord
	Pd – Damper adjusted from inside the box with a lever (for the number of slots $W \geq 3$ only)

* Optional values – if not specified, default values will be used

Sample order: **NSAL-4-1000-AL9010/SRt-2-198P**



- Blocks for REVIT software,
- selection range and
- certificates

are available at www.smay.pl.